



# Smartec STC-IPM3090A Megapixel IP BOX Camera



## Quick Installation Guide

# 1

## Getting Started

### 1.1 PACKAGE CONTENTS

Megapixel IP BOX Cam  
- SXGA series



Power Adaptor (Option)



Product CD



Terminal Blocks for Power & DI/O



Accessory



## 1.2 PHYSICAL DESCRIPTION

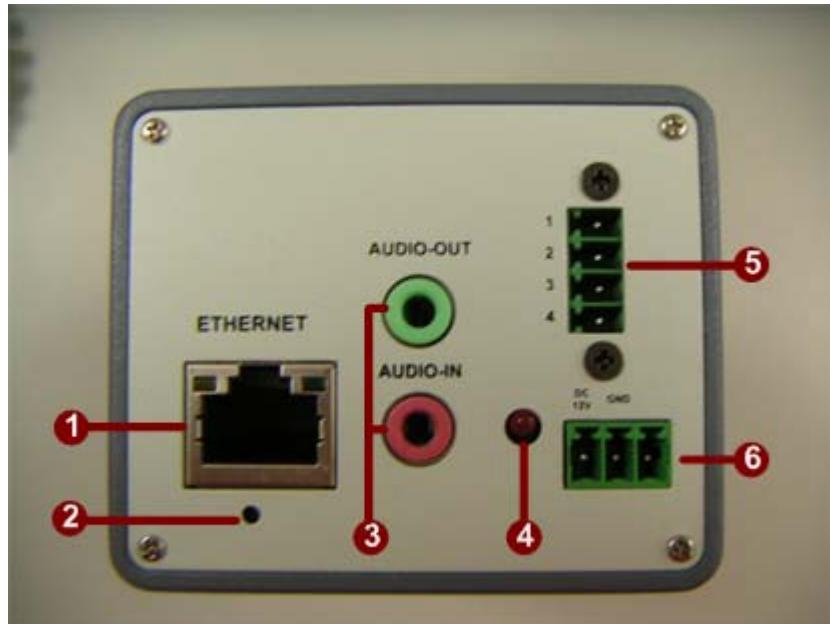

### 1. Ethernet Port

The IP device connects to the Ethernet via a standard RJ45 connector. Supporting NWAY, this IP device can auto detect the speed of local network segment (10Base-T/100Base-TX Ethernet).

### 2. Reset Button

**Step 1:** Switch off IP device by disconnecting the power cable

**Step 2:** Press and continue to hold the Reset Button. Reconnect the power cable while continuing to hold the reset button.

**Step 3:** Keep holding the reset button depressed around 6 seconds, release the reset button. The unit will start up with factory default settings.

### 3. Audio Input / Output

The IP device supports audio input and output with earphone jack

### 4. Action LED Indicator

The LED will light up after IP camera has successfully completed the boot process

### 5. The I/O Terminal Connector

Used in applications for e.g. motion detection, event triggering,

time lapse recording, alarm notifications, etc., the I/O terminal connector provides the interface to:

- 1 transistor output - For connecting external devices such as relays and LED:s. Connected devices can be activated by Output buttons on the Live View page or by an Event Type. The output will show as active (in Event Configuration > Port Status) if the alarm device is activated.
- 1 digital input - An alarm input for connecting devices that can toggle between an open and closed circuit, for example: PIRs, door/window contacts, glass break detectors, etc. When a signal is received the state changes and the input becomes active (shown under Event Configuration > Port Status).

•Auxiliary power and GND

			Description
GND	Pin 1	Ground	
Auxiliary DC Power input (not to power this camera)	Pin 2	Electrically connected in parallel with the connector for the power supply, this pin provides an auxiliary connector for mains power to the unit. This pin can also be used to power auxiliary equipment, with a maximum current of 100mA.	Voltage: 12V DC, Max: 1.2W
Digital Input	Pin 3	Connect to GND to activate, or leave floating (or unconnected) to deactivate.	Must not be exposed to voltages greater than 30V DC.
Transistor Output	Pin 4	Uses an open-collector NPN transistor with the emitter connected to the GND pin. If used with an external relay, a diode must be connected in parallel with the load, for protection against voltage transients.	Max load = <100mA Max voltage = 24V DC (to the transistor)

The I/O terminal pins are numbered left to right, as shown below.



Connect input/output devices to the camera as follows:

1. Attach the cables for the device securely to the supplied green connector block.
2. Once the cables are connected, push the connector block into the terminal

connector (also green) on the camera.

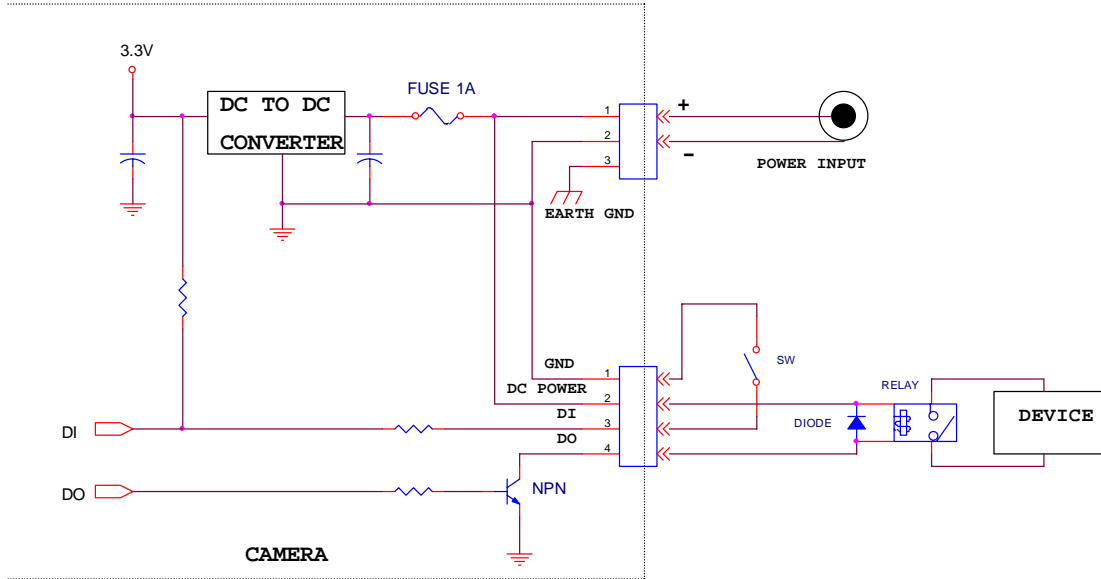

## 6. Power Input

If your power input is DC12V.

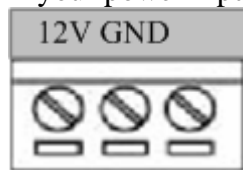

## 1.3 BASIC CONNECTIONS

Follow the procedures below to connect the IP device to the respective apparatuses.

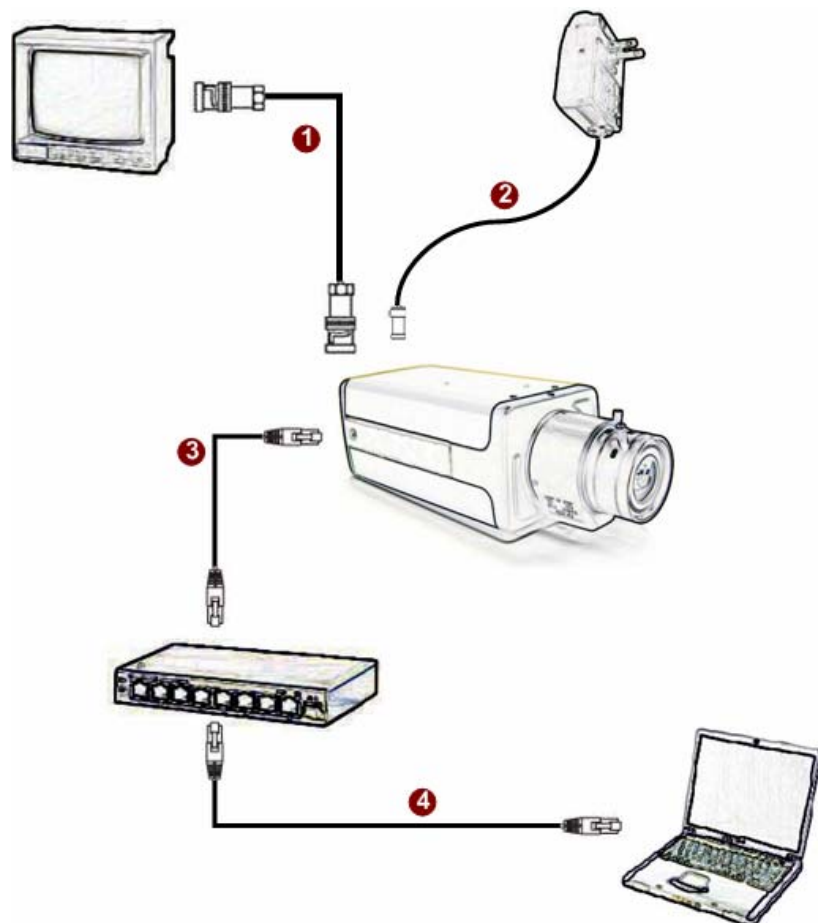

1. Connect the power adaptor to IP device
2. Connect IP device's ethernet port to an Ethernet (RJ45 connectors). If your IP device has PoE built-in, you can regard it as a PD and connect it directly to a PSE device like PoE switch.
3. Connect a PC to the Ethernet hub (RJ45 connectors)

# 2

## Quick Tour

This section guides you with a quick tour on this IP device.

### 2.1 Configure this IP Device

#### 2.1.1 Make sure network environment

Default IP of this IP device is 192.168.0.100. Please make sure this IP device and your PC are on the same network segment before running the installation.

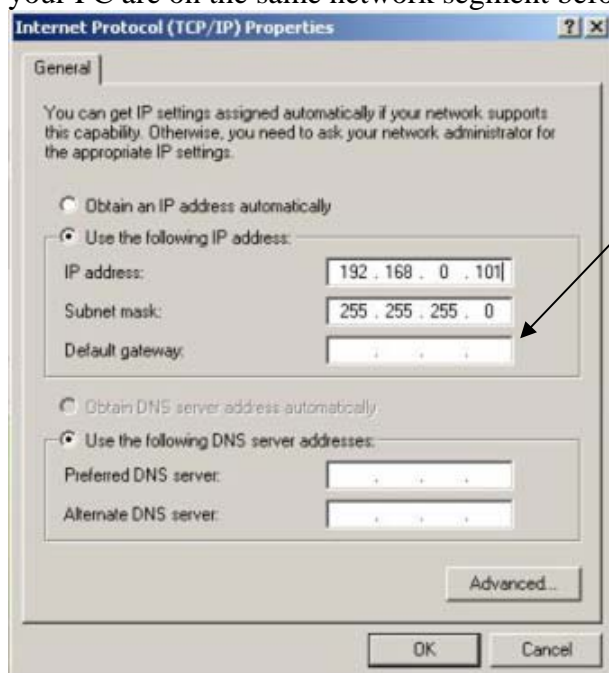

Please set the settings as below.

IP address: 192.168. 0.xxx  
Subnet mask: 255.255.255. 0

(NOTE: xxx should be a number from 1 to 254, but 100 is excepted.)

## 2.1.2 Open Internal Explorer with IP address

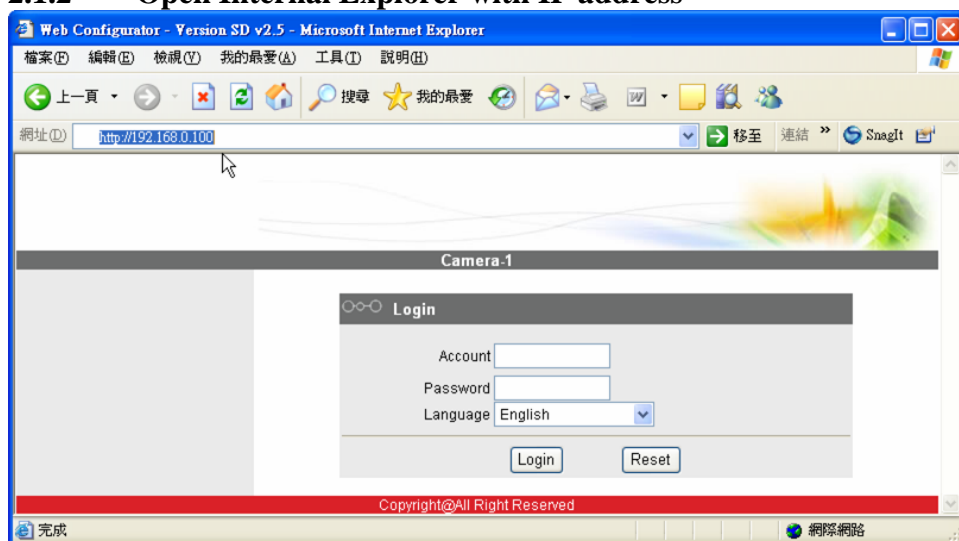



**NOTE:** If your web browser is earlier than IE6, then download IE6 is recommended.

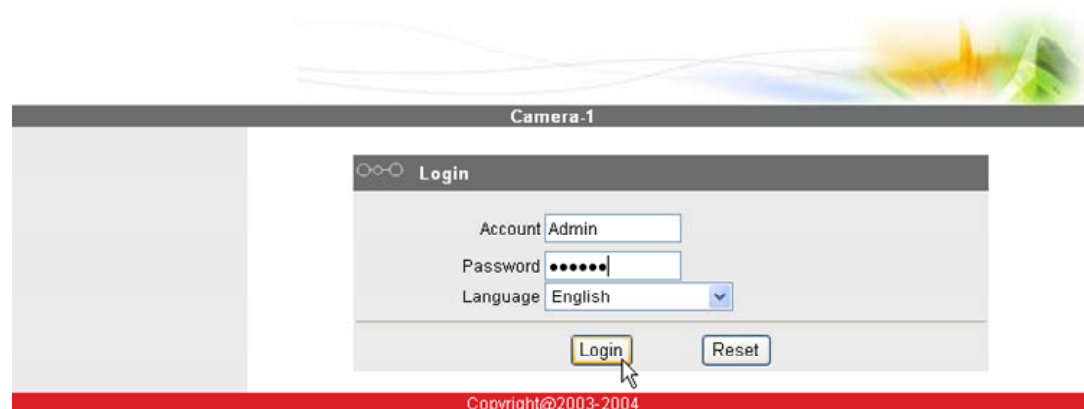

**NOTE:** This IP device default IP address is set to 192.168.0.100

## 2.1.3 Login with default administrator's account & password



**NOTE:** Default administrator account is set to **Admin**, password is set to **123456**, and click  button.

## 2.1.4 Preview the video

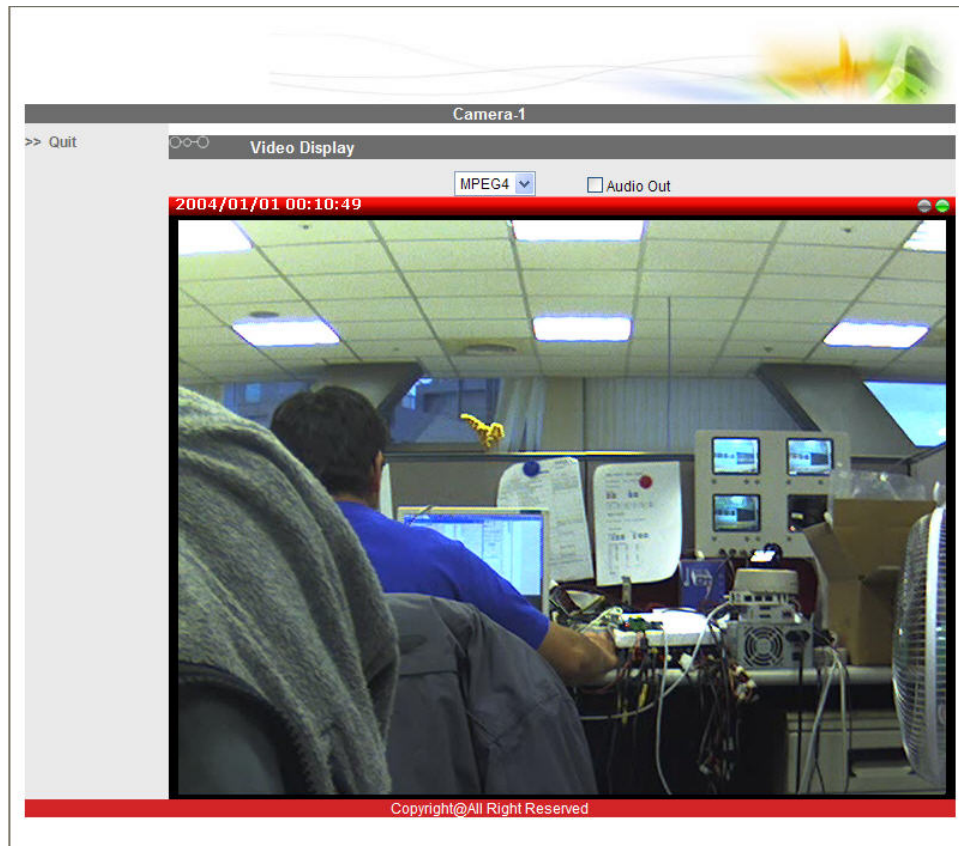

## 2.1.5 Set the new IP address

Camera-1

- >> Video Display
- >> Host Setting
- >> WAN Setting
- >> Date Setting
- >> Video Setting
- >> Video Adjust
- >> User Account
- >> System Info
- >> Firmware
- >> Factory Default
- >> Save Reboot
- >> Logout

WAN Setting \*

Dynamic IP Address

Static IP Address

IP Address  .  .  .

Subnet Mask  .  .  .

ISP Gateway  .  .  .

PPPoE

User Name

Password

DNS Server Setting

Primary DNS Server  .  .  .

Secondary DNS Server  .  .  .

DDNS Server Setting

DDNS Type

Service ISP

Host Name

User Name



Password

Copyright@All Right Reserved

\***IP Address** : The default IP address is 192.168.0.100.

\***Subnet Mask** : The default subnet mask is 255.255.255.0

\***Click**  button

	<b>NOTE:</b> In your Client PC, please make sure the setting of Network Connections Type is set to Auto Negotiation, since this IP device follows MII standard. Otherwise, you might not see the live image.
	<b>IMPORTANT:</b> After the IP address is changed, please record this IP address. There's no way to connect to the IP device if user forgets the new IP address.

## 2.1.6 Check Default Video Setting

Camera-1

>> Video Display  
>> Host Setting  
>> WAN Setting  
>> Date Setting  
>> Video Setting  
>> Video Adjust  
>> Camera Setup  
>> User Account  
>> System Info  
>> Firmware  
>> Factory Default  
>> Save Reboot  
>> Logout

Version V2.0 - Video Setting

Camera Name: Camera-1  
Streaming Method: TCP Only  
Audio In: Disabled  
Analog Video: NTSC  
Resolution: N1280x1024  
Frame Rate Mode: Constant  
Frame Rate: 9  
Video Encoder: MPEG4  
Video Bitrate Mode: Constant Bit Rate  
Video Maximum Bitrate: UNLIMITED  
Bitrate: 3M  
Serial Port Baud Rate: 9600  
Serial Port Control: 8,None,1  
Video Control Port: 6001  
Video Streaming Port: 6002

Apply Reset

Copyright@All Right Reserved



**NOTE:** Please make sure the TV Input (NTSC / PAL) is meet your requirement, and click  button.

**2.1.7** Click **Save Reboot** to restore all settings and please wait about 30 seconds for system reboot.