



Smartec – Day/Night IP Camera

STC-IP3070A



Quick Installation Guide

1

Getting Started

1.1 PACKAGE CONTENTS

IP Outdoor Rugged Dome
(DC12V / PoE / AC24V)



Power Adaptor (Option)



Product CD



Terminal Blocks for Power, DI/O & Audio

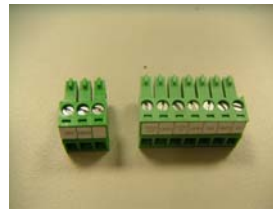

Accessory



1.2 PHYSICAL DESCRIPTION

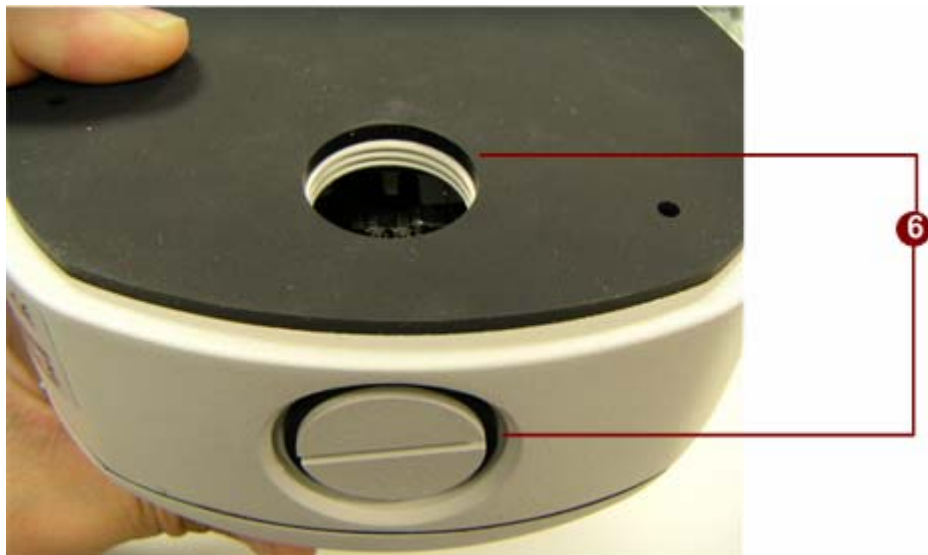
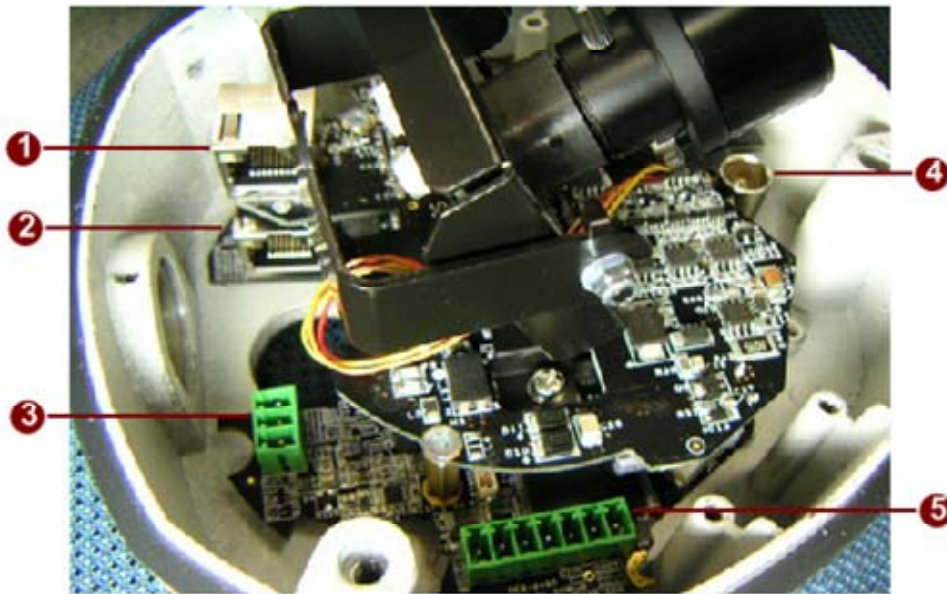

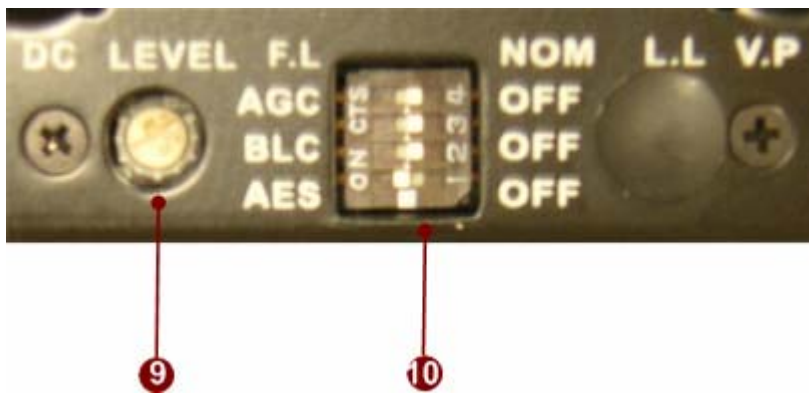
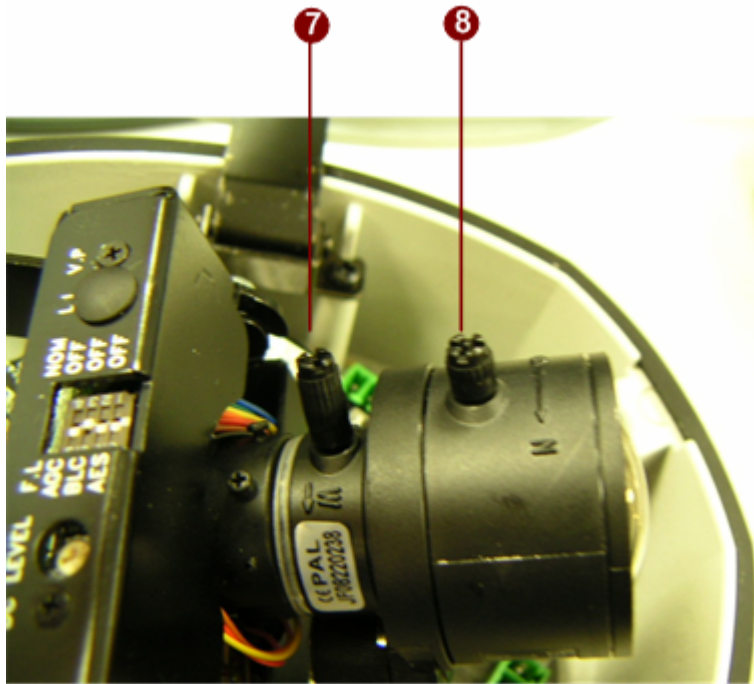

1. **LAN**

The IP Camera connects to the LAN (local area network) via a standard RJ45 connector. Supporting NWAY, this IP outdoor rugged dome can auto detect the speed of local network segment (10Base-T/100Base-TX Ethernet).

2. **WAN**

The IP Camera connects to the WAN (wide area network) via a standard RJ45 connector. Supporting NWAY, this IP outdoor rugged dome can auto detect the speed of local network segment (10Base-T/100Base-TX Ethernet).

3. **Power Input**

If your power input is DC12V. Please follow the description on the connector to connect to power.



| PIN | NAME | DESCRIPTION |
|-----|------|----------------|
| 1 | 12V | DC Power Input |
| 2 | GND | Ground Pin |

If your power input is AC24V. Please follow the description on the connector to connect to power.

| PIN | NAME | DESCRIPTION |
|-----|------|-------------------|
| 1 | N | AC Power Input |
| 2 | L | |
| 3 | GND | E-Ground of power |

4. **Analog Video Output**

The IP outdoor rugged dome supports one channel analog video output.

5. **DI/O**

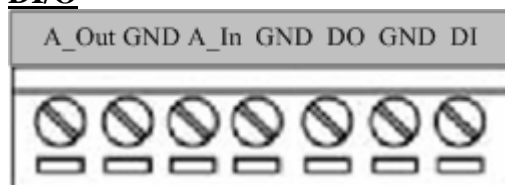

| PIN | NAME | DESCRIPTION |
|-----|-------|----------------|
| 1 | A_Out | Audio Output |
| 2 | GND | Ground Pin |
| 3 | A_In | Audio Input |
| 4 | GND | Ground Pin |
| 5 | DO | Digital Output |
| 6 | GND | Ground Pin |
| 7 | DI | Digital Input |

DI: To Trigger Logic Level 0: 0~0.4V; Normal Logic Level 1: 3.3~30V

DO: To Trigger Logic Level 0: 0.1~0.6V; Normal Logic Level 1: 2.4~5V

6. Conduit Hole

These conduit holes are used for cables to go through.

7. Zoom Lever

Move this lever to adjust the optical zoom. After adjusting, rotate it clockwise to fix it.

8. Focus Lever

Move this lever to adjust the Focus. After adjusting, rotate it clockwise to fix it.

9. Video DC level Adjustment

Rotate it adjust the overall lighting for this camera.

10. CCD Functions DIP-switch

| Item | Description | ON | OFF |
|------|------------------------|---------|---------|
| AES | Auto Electric Shutter | | Default |
| BLC | Backlight Compensation | | Default |
| AGC | Auto Gain Control | Default | |
| F.L. | Flickerless | | Default |

11. Reset Button



Step 1: Switch off IP device by disconnecting the power cable

Step 2: Press and continue to hold the Reset Button. Reconnect the power cable while continuing to hold the reset button.

Step 3: Keep holding the reset button depressed around 6 seconds, release the reset button. The unit will start up with factory default settings.

1.3 INSTALLATION PROCEDURE

There are three types of installation of this IP outdoor rugged dome series.

| | Surface mount | Flush mount | Wall mount |
|---------------------------|---|--|---|
| Pictures |  |  |  |
| Optional Bracket required | | • | • |

The mounting procedure can be divided into two parts,

1st: Connect the IP outdoor rugged dome series

2nd: Mount the IP outdoor rugged dome series

1.3.1 Connect the IP Outdoor Rugged Dome

1.3.1.1 Remove the cover

Remove the dome cover with special hex wrench in the accessory bag.



1.3.1.2 Insert the cable

There are two conduit holes, one is at the dome bottom and the other one is at the side of rugged dome with plug. Remove the plug if your cable will go through the one at the side of rugged dome

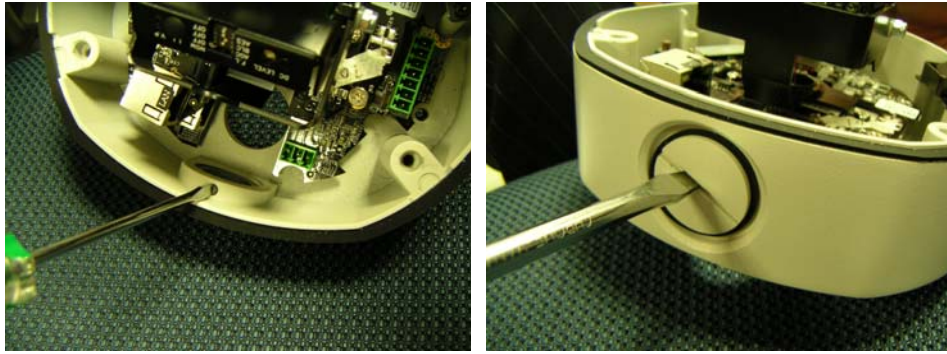

1.3.1.3 Connect cables to connectors

Please follow the instruction at Chapter 2: Physical Description, for how to connect to each connector.

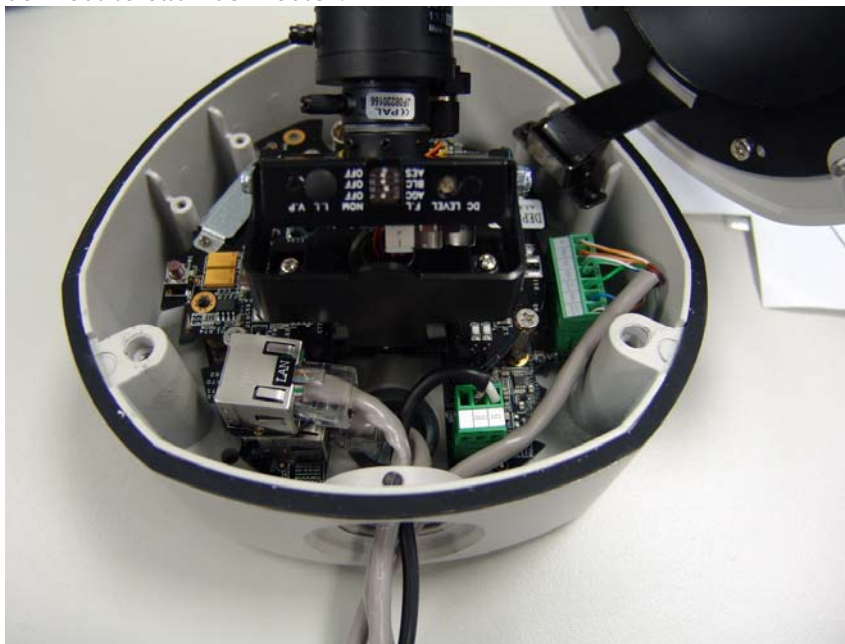

1.3.1.4 LED Description

There are three LEDs in the system. They are indicators for power, fan and heater respectively. According to operating temperature, the different LED will be lighted for different situation.

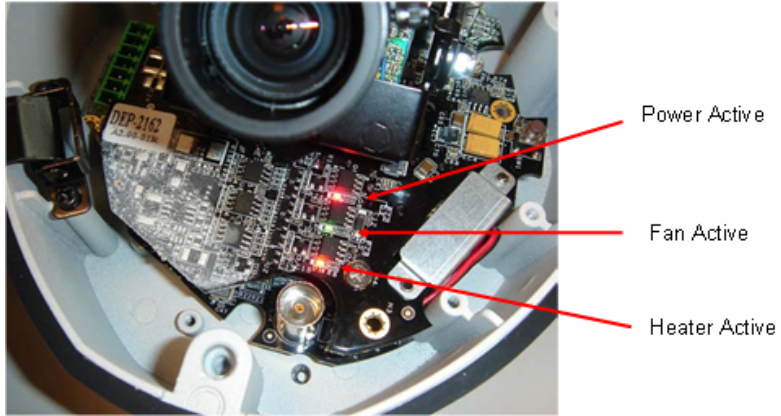
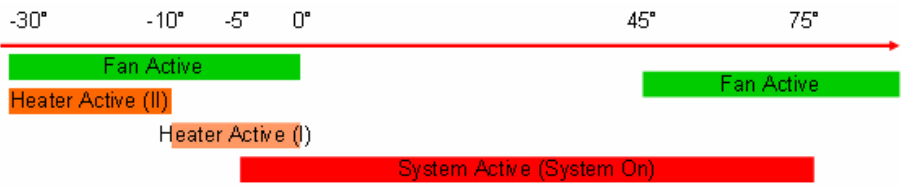

 **NOTE:** Temperatures indicate here is spec for internal IC temperature, not for operating temperature.

1.4 Mount the IP Outdoor Fixed Dome (Surface)

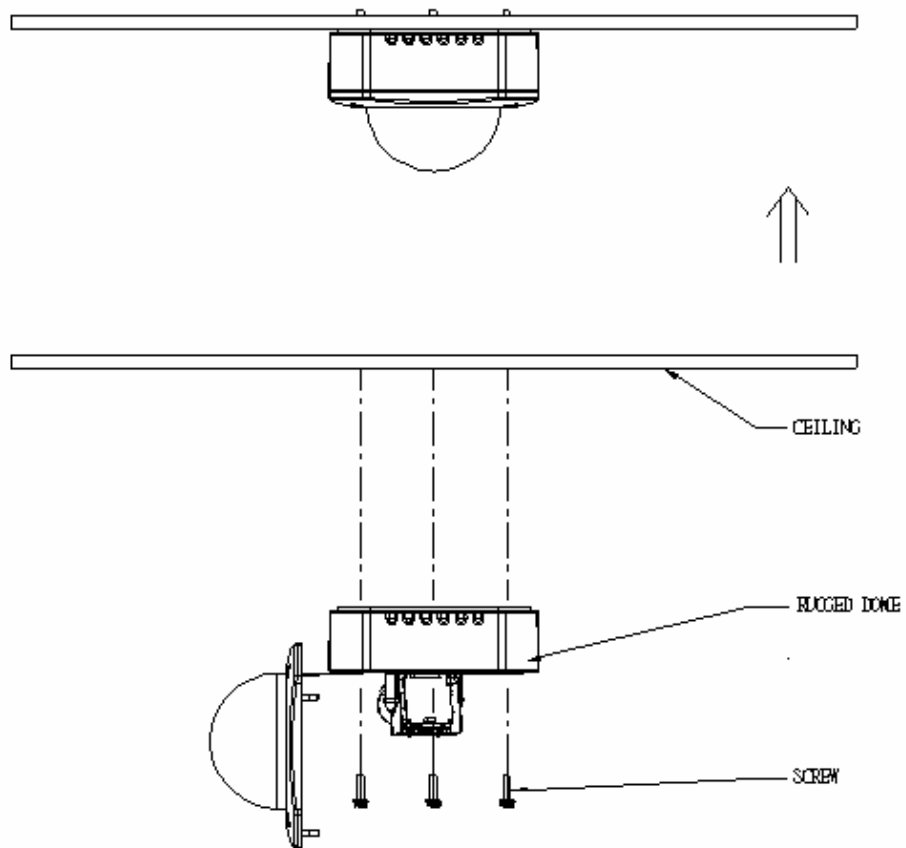

1.5 Mount the IP Outdoor Fixed Dome (Flush)

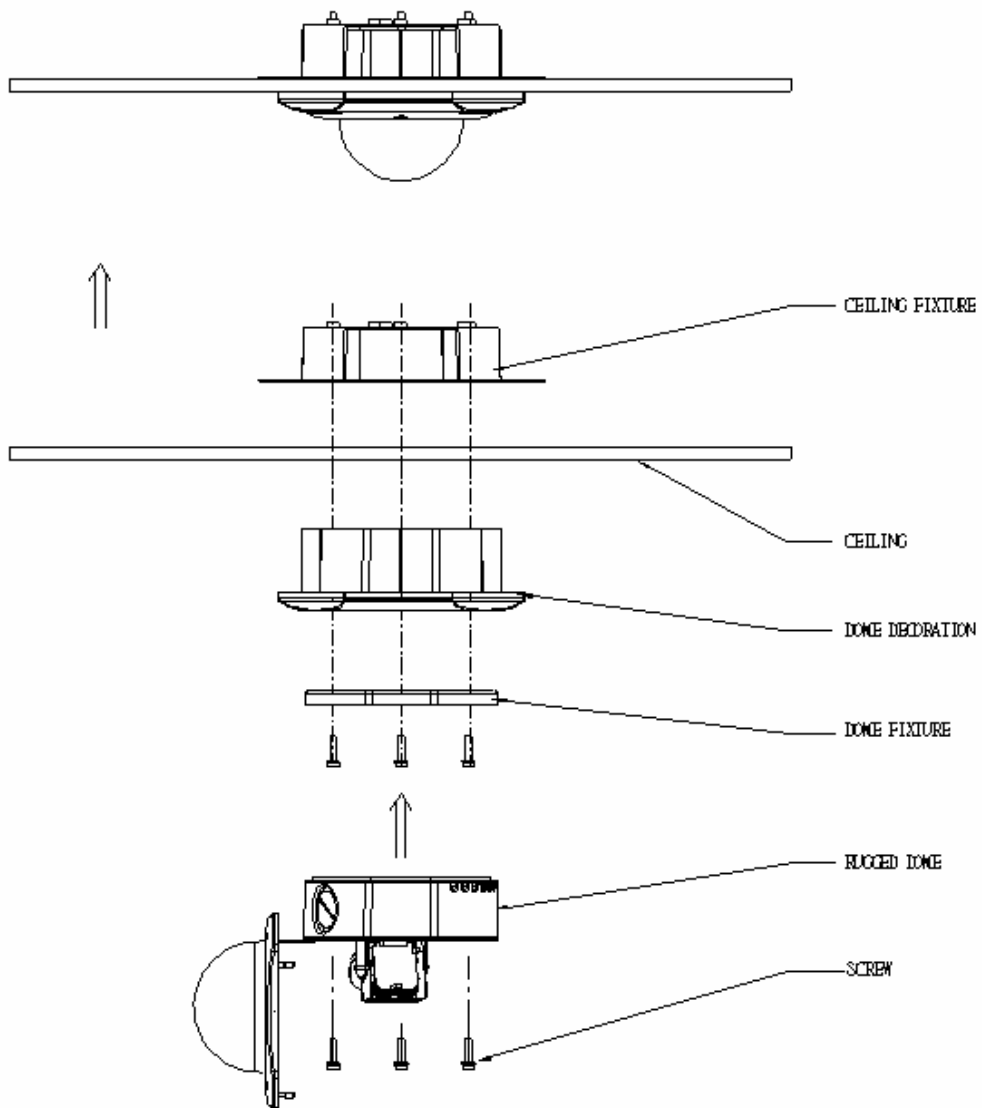

1.6 Mount the IP Indoor Fixed Dome (Wall)

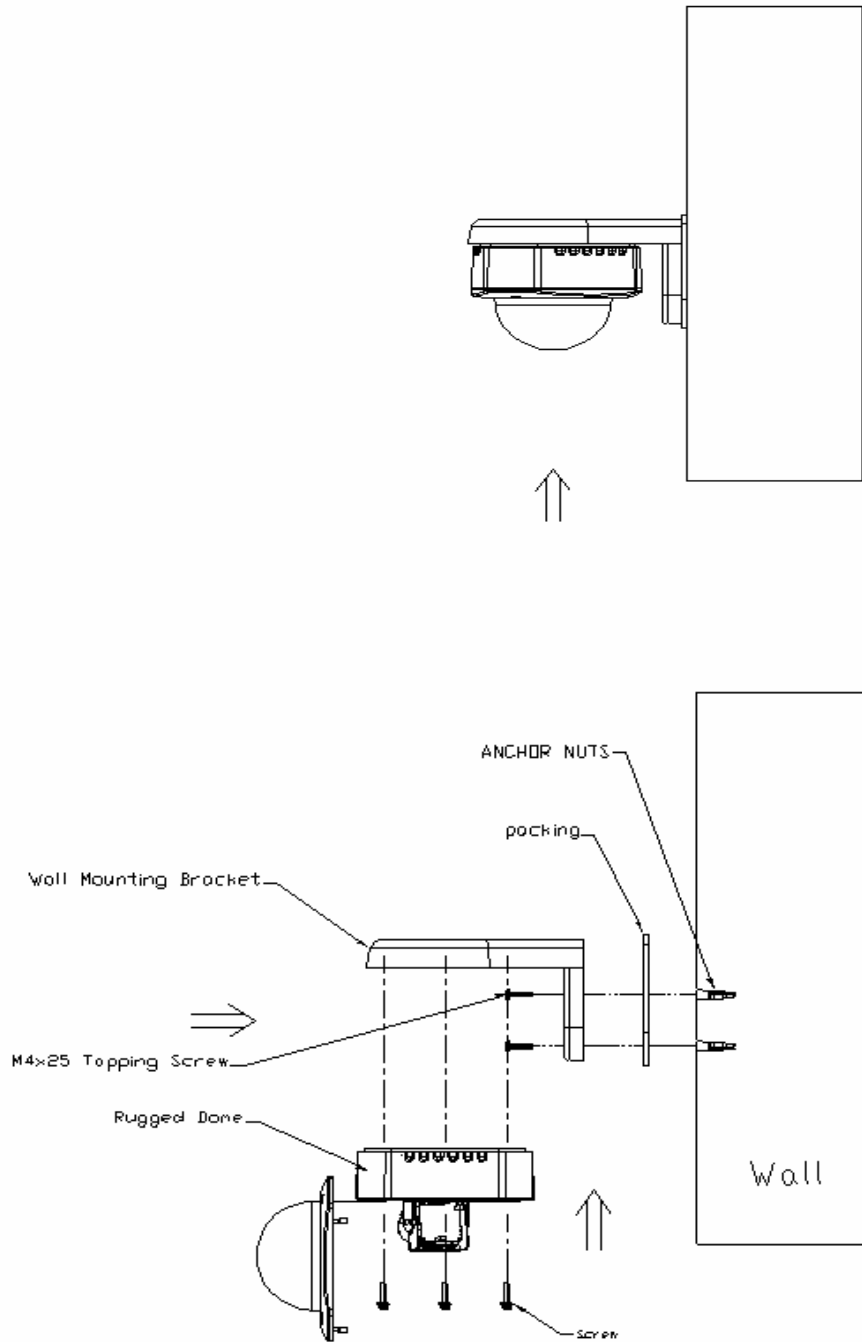

2

Quick Tour

This section guides you with a quick tour on IP outdoor rugged dome.

2.1 Configure the IP Outdoor Rugged Dome

2.1.1 Make sure network environment

Default IP of IP outdoor rugged dome is 192.168.0.100. Please make sure IP outdoor rugged dome and your PC are on the same network segment before running the installation.

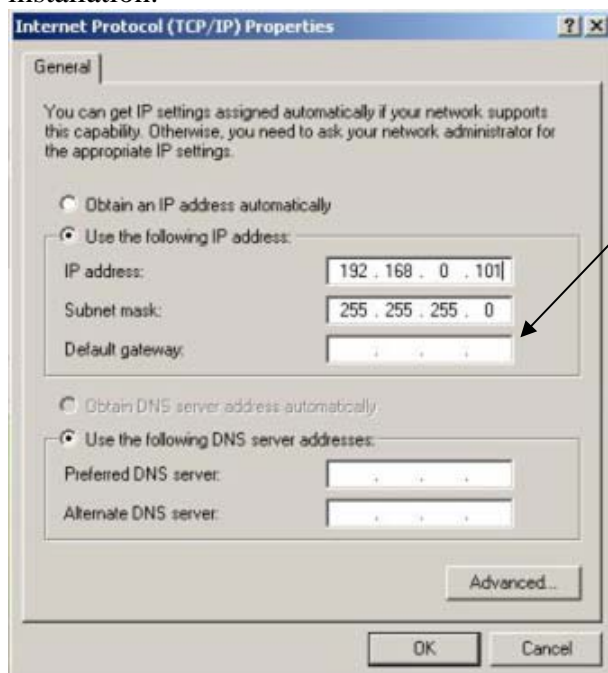

Please set the settings as below.

IP address: 192.168. 0.xxx
Subnet mask: 255.255.255. 0

(NOTE: xxx should be a number from 1 to 254, but 100 is excepted.)

2.1.2 Open Internal Explorer with IP address

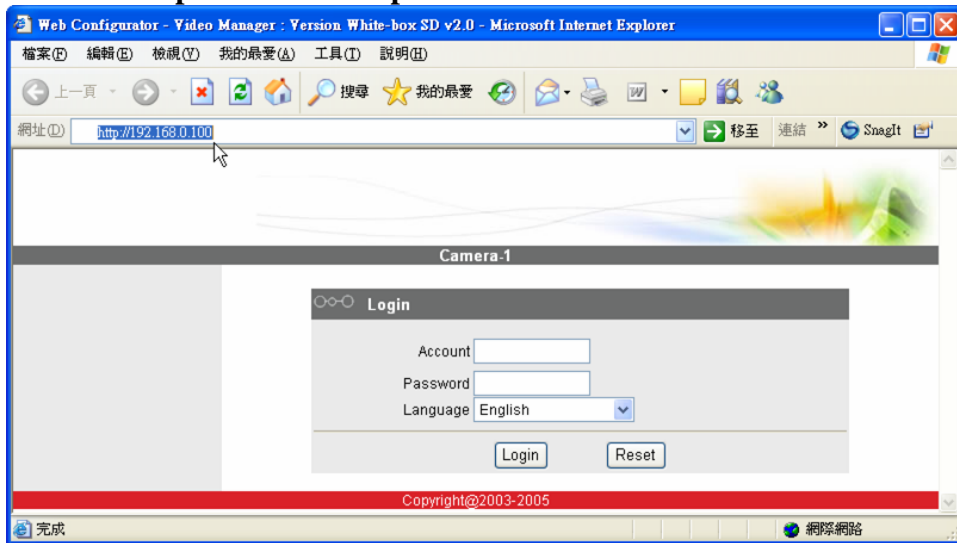



NOTE: If your web browser is earlier than IE6, then download IE6 is recommended.

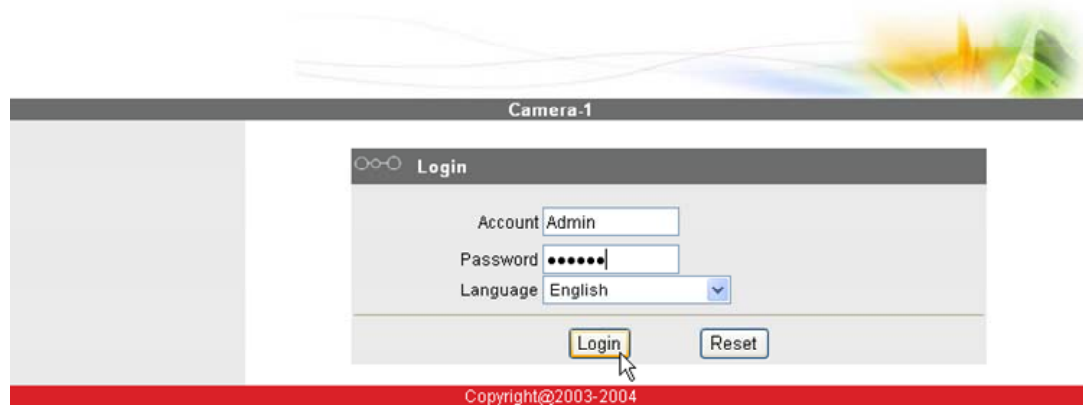

NOTE: The IP outdoor rugged dome default IP address is set to 192.168.0.100

2.1.3 Login with default administrator's account & password



NOTE: Default administrator account is set to **Admin**, password is set to **123456**, and click  button.

2.1.4 Preview the video



NOTE: In your Client PC, please make sure the setting of Network Connections Type is set to Auto Negotiation, since IP outdoor rugged dome follows MII standard. Otherwise, you might not see the live image.

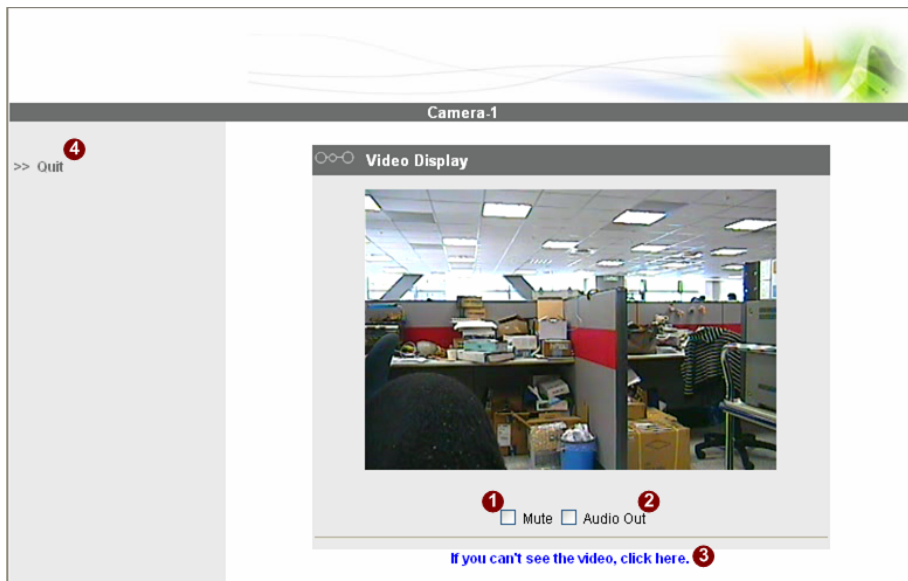

2.1.5 Set the new IP address



***Host Name** : Enter in the domain name.

***Language** : Language setting for Web Configurator after Save Reboot. Default setting is English.

***IP Address** : The IP address of the LAN interface. The default IP address is 192.168.0.100.

***Subnet Mask** : The subnet mask of the LAN interface. The default subnet mask is 255.255.255.0

***Click**  button

| | |
|---|--|
|  | NOTE: Check with your MIS department, if Client PC and IP outdoor rugged dome are setting in different VLANs, please connect to WAN port. |
|  | NOTE: In your Client PC, please make sure the setting of Network Connections Type is set to Auto Negotiation, since IP outdoor rugged dome follows MII standard. Otherwise, you might not see the live image. |
|  | IMPORTANT: After the IP address is changed, please record this IP address. There's no way to connect to the IP outdoor rugged dome if user forgets the new IP address. |

2.1.6 Check Default Video Setting



The streaming type [Version 1.0] – without audio function

The streaming type [Version 2.0] – with audio function

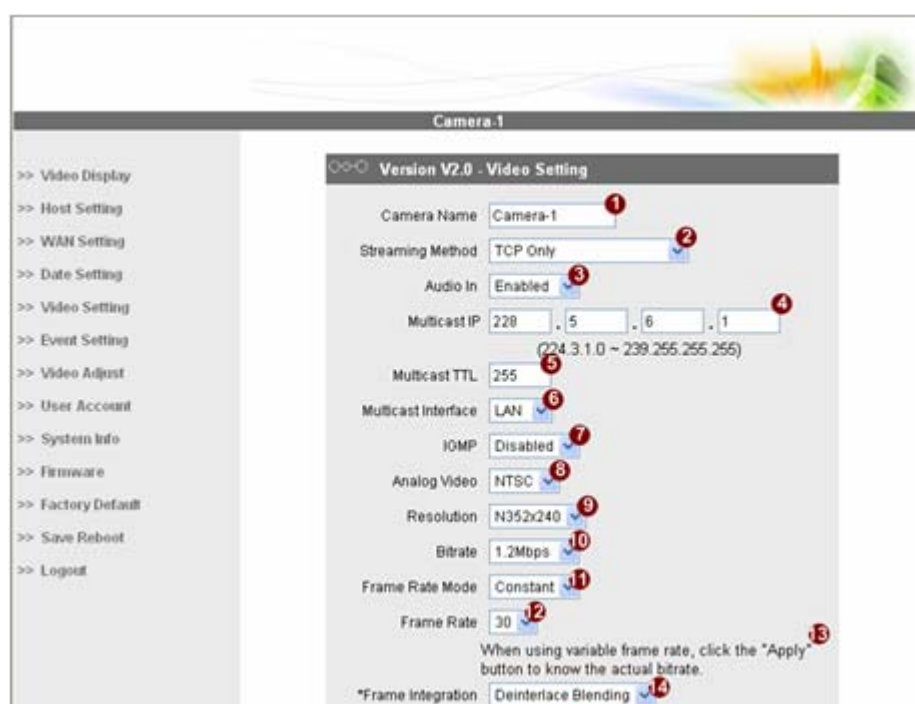

NOTE: Please make sure the TV Input (NTSC / PAL) is meet your requirement, and click **Apply** button.

2.1.7 Click **Save Reboot** to restore all settings and please wait about 30 seconds for system reboot.